

Article number: 604146014037

Description: Timing belt pulley with hub
14 XL 037

Measures

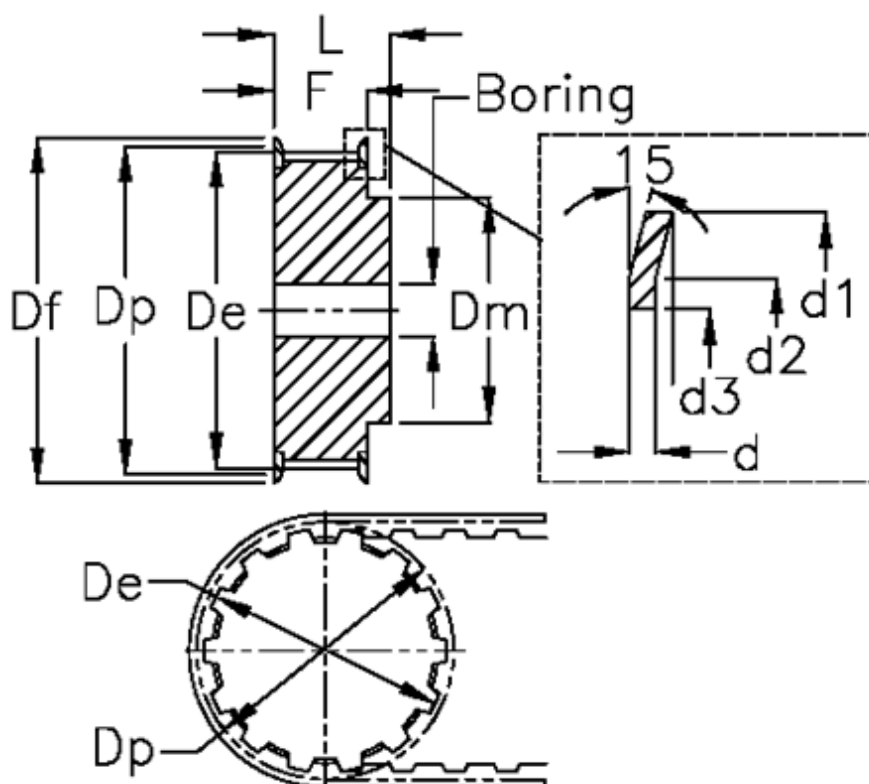

d = 1	F = 14.3	Width = XL 037
d1 = 28	Flange type = F09	
d2 = 24	L = 19.8	
d3 = 17.8	Max bore = 9.5	
De = 22.13	Pitch = 1/5"	
Df = 28	Pre-drilled = 6	
Dm = 14.3	Tooth number = 14	
Dp = 22.64	Weight = 0.04	